

# Embedded Access Control User Manual

## 1. Parameters

Working voltage	DC 9-12V
Working current	60mA~80mA
Reading range	5~10cm
Working temperature	-40℃~60℃
Cards capacity	2000PCS
Supporting card style	EM card
Working frequency	125KHz

## 2. Connecting instruction

### J1

pin	color	silk-screen	function
1	RED	+12V	12V input
2	BLACK	GND	
3	YELLOW	NO	relay NO
4	WHITE	COM	relay COM
5	GREEN	NC	relay NC
6	BLUE	POEN	Exit button(Active-low)





### J2 (No this function)

pin	color	silk-screen	function
1	GREEN	5V	5V
2	WHITE	GND	
3	BLACK	DATA	Infrared data

### J3-B

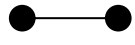
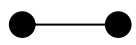
pin	color	silk-screen	function
1	RED	TX1	Antenna input
2	BLACK	TX2	Antenna output

## 3. Short circuit jumper instruction

short circuit pin	jumper place	state
S1		Delay time for 5S
S1		Delay time for 1S
S2		<b>Setup master cards</b>
S2		Normal working model
S3		Delay output active- high 12V
S3		Delay output active- low GND
S3	blank	Passive output

#### 4. PCB

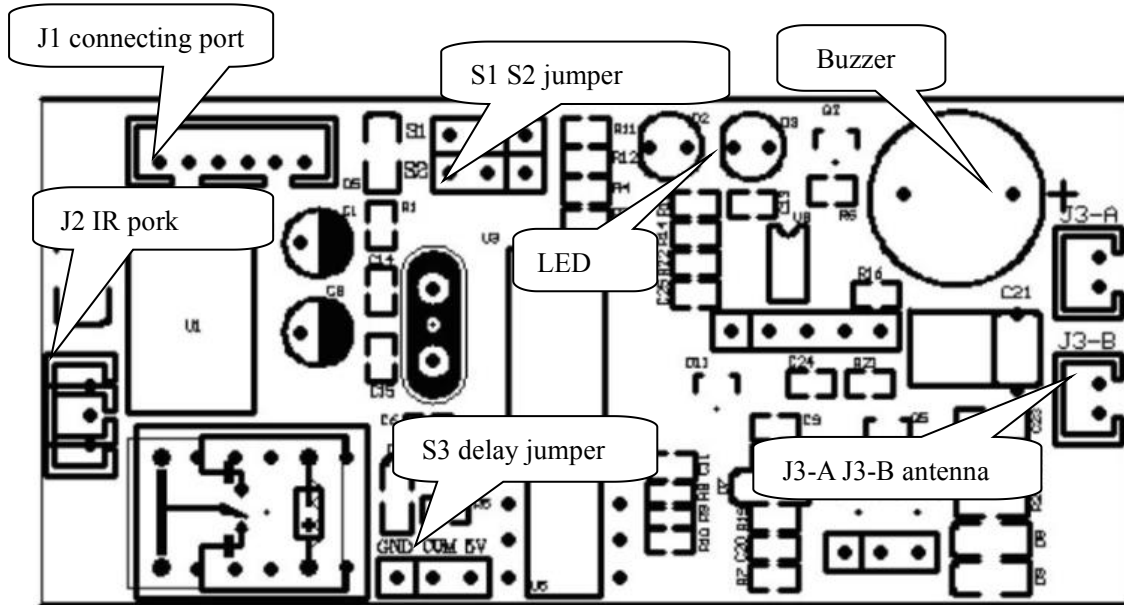

#### 5. Operating instruction

##### Master card:

Power off, put S2's pin1 and pin2 short-circuit, then power on, red LED, green LED will blink alternately, read two cards continuously. First card is the add card, the second card is the clear card. The power off, put S2's pin2 and pin3 short-circuit.

##### Add cards:

Under working state, read the add card, the green LED will blink, read new cards what need to add. If you finished read, then read the add card again to finish operate.

##### Clear cards:

Under working state, read the clear card, the red LED will blink, read cards what need to clear, then read the clear card again to finish operate.

##### Clear all cards:

Under working state, read the clear card, red LED will blink, then read the add card, read the clear card again. After 5s, clear all cards succeed.

##### Infrared operate:

Enter program: press "1234" then press "CALL".

Continuously add cars: press "1" + "CALL", green LED will blink, then read cards continuously.

Continuously clear cards, press "3" + "CALL", red LED will blink, then read cards continuously.

Add Card with number: press "0" + "XXXXXXXXXX" (10bit card chip number) + "CALL". (while press "0", the green LED will light on, then press 10bit card chip number)

Clear card with number: press "2" + "XXXXXXXXXX" (10bit card chip number) + "CALL", (while press "2", the red LED will light on, press 10 bit card chip number.)

Clear all cards: press "4" + "CALL", after several second, will hear "B" sound, clear finished.

Door normal open start: press "5" + "CALL"

Door normal close start: press "6" + "CALL"

Open door once time: press "7" + "CALL"

Change password: press "8" + "XXXX" (4bit password) + "CALL".

EXIT program: press "EIXT", or do not any operating, it will be auto-exit after 10s.